



Aluminum electrolytic capacitors

Single-ended capacitors

Series/Type: B41851, B43851

The following products presented in this data sheet are being withdrawn.

Ordering Code	Substitute Product	Date of Withdrawal	Deadline Last Orders	Last Shipments
see following page		2013-10-18	2014-01-18	2014-04-18

For further information please contact your nearest EPCOS sales office, which will also support you in selecting a suitable substitute. The addresses of our worldwide sales network are presented at www.epcos.com/sales.

© EPCOS AG 2015. Reproduction, publication and dissemination of this publication, enclosures hereto and the information contained therein without EPCOS' prior express consent is prohibited.

EPCOS AG is a TDK Group Company.

Affected products (Ordering code)

B41851A2227*
B41851A2337*
B41851A3107*
B41851A3227*
B41851A4107*
B41851A4686*
B41851A5107*
B41851A5476*
B41851A6105*
B41851A6106*
B41851A6225*
B41851A6226*
B41851A6335*
B41851A6336*
B41851A6475*
B41851A6476*
B41851A6685*

B41851A7336*
B41851A7476*
B41851A7686*
B41851A8106*
B41851A8226*
B41851A8336*
B41851A9104*
B41851A9105*
B41851A9106*
B41851A9224*
B41851A9225*
B41851A9334*
B41851A9335*
B41851A9474*
B41851A9475*
B41851A9684*
B41851B6106*

B41851F4227*
B41851F5686*
B41851F6686*
B41851F7107*
B41851F8226*
B41851F8476*
B41851S3227*
B41851S5157*
B41851S6476*
B41851S7107*
B41851S7476*
B43851A1105*
B43851A1225*
B43851A1335*
B43851A1474*
B43851A2105*
B43851A2225*

B43851A2335*
B43851A2474*
B43851A4105*
B43851A4474*
B43851A4684*
B43851F1475*
B43851F2105*
B43851F2225*
B43851F2474*
B43851F2684*
B43851F4225*
B43851G2475*
B43851K2335*



Single-ended capacitors

B41851, B43851

Standard series – 105 °C

General-purpose grade capacitors

Applications

- General-purpose applications in the entertainment industry
- Semi-professional to professional application range
- For filtering, coupling and pulse circuits
- Switch-mode power supplies

Features

- Compact dimensions
- High CV product, i.e. very compact
- RoHS-compatible

Construction

- Radial leads
- Charge-discharge proof, polar
- Aluminum case with insulating sleeve
- Minus pole marking on the insulating sleeve
- Case with safety vent from diameter 6.3 mm

Delivery mode

Terminal configurations and packing:

- Bulk
- Taped, Ammo pack
- Cut
- Kinked
- PAPR (protection against polarity reversal):
crimped leads, J leads, bent leads

Refer to chapter "Single-ended capacitors – Taping, packing and lead configurations" for further details.

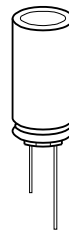



B41851, B43851

Standard series – 105 °C

Specifications and characteristics in brief

Series	B41851	B43851
Rated voltage V_R	6.3 ... 100 V DC	160 ... 450 V DC
Surge voltage V_S	$1.15 \cdot V_R$	$1.1 \cdot V_R$
Rated capacitance C_R	0.1 ... 10000 μF	0.47 ... 680 μF
Capacitance tolerance	$\pm 20\% \triangleq M$	$\pm 20\% \triangleq M$
Dissipation factor $\tan \delta$ (20 °C, 120 Hz)	For capacitance higher than 1000 μF add 0.02 for every increase of 1000 μF .	
	V_R (V DC)	6.3 10 16 25 35 50 63 100 160 ... 450
	$\tan \delta$ (max.)	0.28 0.24 0.20 0.16 0.14 0.12 0.12 0.10 0.20
Leakage current I_{leak} (20 °C, 5 min)	$I_{\text{leak}} = 0.01 \mu\text{A} \cdot \left(\frac{C_R}{\mu\text{F}} \cdot \frac{V_R}{V} \right)$ or 3 μA , whichever is greater	$I_{\text{leak}} = 0.03 \mu\text{A} \cdot \left(\frac{C_R}{\mu\text{F}} \cdot \frac{V_R}{V} \right) + 15 \mu\text{A}$
Self-inductance ESL	Diameter (mm)	≤ 6.3 8 ... 12.5 16 18 20 ... 25
	ESL (nH)	15 20 26 34 40
Useful life 105 °C; V_R ; $I_{AC,R}$ 40 °C; V_R ; $1.8 \cdot I_{AC,R}$ 40 °C; V_R ; $2.1 \cdot I_{AC,R}$		> 2000 h
		> 250000 h
		–
Requirements	$\Delta C/C$	$\leq \pm 45\%$ of initial value
	$\tan \delta$	≤ 3 times initial specified limit
	I_{leak}	\leq initial specified limit
Voltage endurance test 105 °C; V_R		1000 h
		1000 h
Post test requirements	$\Delta C/C$	$\leq \pm 30\%$ of initial value
	$\tan \delta$	≤ 2 times initial specified limit
	I_{leak}	\leq initial specified limit
Vibration resistance test	To IEC 60068-2-6, test Fc: Frequency range 10 Hz ... 2 kHz, displacement amplitude 1.5 mm, acceleration max. 20 g, duration 3×2 h. Capacitor rigidly clamped by the aluminum case.	
IEC climatic category	To IEC 60068-1:	
	$V_R \leq 250$ V: 40/105/56 (–40 °C/+105 °C/56 days damp heat test) $V_R \geq 350$ V: 25/105/56 (–25 °C/+105 °C/56 days damp heat test)	
Sectional specification	IEC 60384-4	



B41851, B43851

Standard series – 105 °C

Dimensional drawings

With stand-off rubber seal

Diameters (mm):

6.3, 10, 12.5, 16, 18, 22, 25

With flat rubber seal

Diameters (mm):

5, 8, 20

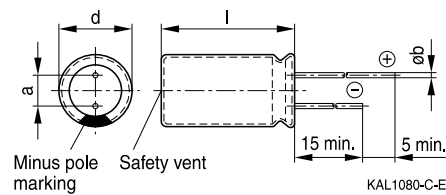
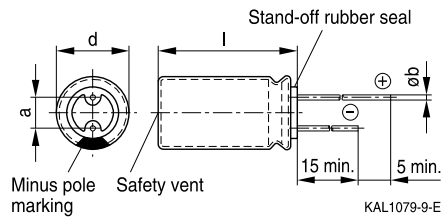

Safety vent for diameter ≥ 6.3 mm.

Dimensions and weights

Dimensions (mm)				Approx. weight
d +0.5	l	a ±0.5	b	g
5	11 +1.0	2.0	0.50 ±0.05	0.5
6.3	11 +1.0	2.5	0.50 ±0.05	0.7
8	11.5 +1.5	3.5	0.60 ±0.05	1.0
10	12.5 +1.0	5.0	0.60 ±0.05	1.6
10	16 +1.0	5.0	0.60 ±0.05	1.9
10	20 +2.0	5.0	0.60 ±0.05	2.6
12.5	20 +2.0	5.0	0.60 ±0.05	3.6
12.5	25 +2.0	5.0	0.60 ±0.05	4.5
16	20 +2.0	7.5	0.80 ±0.05	5.5
16	25 +2.0	7.5	0.80 ±0.05	7.5
16	31.5 +2.0	7.5	0.80 ±0.05	7.8
18	31.5 +2.0	7.5	0.80 ±0.1	11.0
18	35 +2.0	7.5	0.80 ±0.1	13.0
18	40 +2.0	7.5	0.80 ±0.1	16.0
20	35 +2.0	10.0	1.0 ±0.1	18.0
20	40 +2.0	10.0	1.0 ±0.1	20.0
22	40 +2.0	10.0	1.0 ±0.1	23.0
25	40 +2.0	12.5	1.0 ±0.1	25.0



B41851

Standard series – 105 °C



Overview of available types – B41851

Other voltage and capacitance ratings are available upon request.

V _R (V DC)	6.3	10	16	25
	Case dimensions d × l (mm)			
C _R (μF)				
47				5 × 11
68				5 × 11
100		5 × 11	5 × 11	6.3 × 11
220		6.3 × 11	6.3 × 11	8 × 11.5
330	6.3 × 11	8 × 11.5	8 × 11.5	8 × 11.5 10 × 12.5
470	8 × 11.5	8 × 11.5	8 × 11.5	10 × 12.5
680	8 × 11.5	10 × 12.5	10 × 12.5	10 × 16
1000	10 × 12.5	10 × 12.5	10 × 16	10 × 20
1500	10 × 16	10 × 20	10 × 20	12.5 × 20
2200	10 × 20	10 × 20	12.5 × 20	12.5 × 25
3300	10 × 20	12.5 × 25	12.5 × 25 16 × 25	16 × 25
4700	12.5 × 25	16 × 20	16 × 25	16 × 31.5
6800		16 × 25	16 × 31.5	18 × 35
10000		18 × 31.5	18 × 35	20 × 40



B41851

Standard series – 105 °C

V _R (V DC)	35	50	63	100
	Case dimensions d × l (mm)			
C _R (μF)				
0.10				5 × 11
0.22				5 × 11
0.33				5 × 11
0.47				5 × 11
0.68				5 × 11
1.0		5 × 11		5 × 11
2.2		5 × 11		5 × 11
3.3		5 × 11		5 × 11
4.7		5 × 11		5 × 11
10		5 × 11	5 × 11	6.3 × 11
22		5 × 11	5 × 11	8 × 11.5
33	5 × 11	6.3 × 11	6.3 × 11	8 × 11.5 10 × 12.5
47	5 × 11	6.3 × 11	6.3 × 11	10 × 12.5
68	6.3 × 11	6.3 × 11	8 × 11.5	10 × 16
100	6.3 × 11	8 × 11.5	8 × 11.5	10 × 20
220	8 × 11.5	10 × 12.5	10 × 16	12.5 × 25
330	10 × 12.5	10 × 16	10 × 20	16 × 25
470	10 × 16	10 × 20	12.5 × 20	16 × 31.5
680	10 × 20	12.5 × 20	16 × 20	18 × 40
1000	12.5 × 20	12.5 × 25	16 × 25	18 × 40
1500	16 × 20	16 × 25	18 × 31.5	
2200	16 × 25	16 × 31.5 18 × 35	18 × 35	
3300	16 × 31.5	18 × 35	20 × 40	
4700	18 × 35	20 × 40	25 × 40	
6800	18 × 40			



B43851

Standard series – 105 °C



Overview of available types – B43851

Other voltage and capacitance ratings are available upon request.

V _R (V DC)	160	200	250	350	400	450
	Case dimensions d × l (mm)					
C _R (μF)						
0.47			6.3 × 11	6.3 × 11		
0.68			6.3 × 11	6.3 × 11		
1.0	6.3 × 11	6.3 × 11	6.3 × 11	6.3 × 11		
2.2	6.3 × 11	6.3 × 11	6.3 × 11	6.3 × 11 8 × 11.5	8 × 11.5	8 × 11.5
3.3	6.3 × 11	6.3 × 11	6.3 × 11	8 × 11.5	8 × 11.5	10 × 12.5
4.7	6.3 × 11	6.3 × 11	8 × 11.5	8 × 11.5	10 × 12.5	10 × 12.5
10	8 × 11.5	8 × 11.5	10 × 12.5	10 × 16	10 × 20	10 × 20
22	10 × 12.5 10 × 16	10 × 16	10 × 20	12.5 × 20	12.5 × 25	12.5 × 25
33	10 × 16 10 × 20	10 × 20	12.5 × 20	12.5 × 25	16 × 20	16 × 25
47	10 × 20 12.5 × 20	12.5 × 20	12.5 × 25	16 × 25	16 × 25	16 × 31.5
68	12.5 × 20	12.5 × 25	16 × 25	16 × 31.5	18 × 31.5	18 × 35
100	12.5 × 25 16 × 25	16 × 25	16 × 31.5	18 × 35	18 × 40	20 × 40
220	16 × 31.5 18 × 31.5	18 × 31.5	18 × 40			
330	18 × 35	20 × 35	22 × 40			
470	20 × 40	22 × 40				
680	25 × 40					



B41851

Standard series – 105 °C

Technical data and ordering codes – B41851

C_R 120 Hz 20 °C μF	Case dimensions $d \times l$ mm	ESR_{max} 120 Hz 20 °C Ω	$I_{\text{AC,R}}$ 120 Hz 105 °C mA	$I_{\text{AC,max}}$ 120 Hz 85 °C mA	Ordering code (composition see below)
---	---------------------------------------	---	---	--	--

$V_R = 6.3 \text{ V DC}$

330	6.3 × 11	1.4	195	275	B41851A2337M***
470	8 × 11.5	1.0	265	370	B41851B2477M***
680	8 × 11.5	0.68	295	413	B41851F2687M***
1000	10 × 12.5	0.46	455	635	B41851A2108M***
1500	10 × 16	0.31	525	735	B41851F2158M***
2200	10 × 20	0.23	710	995	B41851A2228M***
3300	10 × 20	0.16	840	1175	B41851A2338M***
4700	12.5 × 25	0.12	1120	1570	B41851A2478M***

$V_R = 10 \text{ V DC}$

100	5 × 11	4.0	105	150	B41851A3107M***
220	6.3 × 11	1.8	175	245	B41851A3227M***
330	8 × 11.5	1.2	220	310	B41851B3337M***
470	8 × 11.5	0.85	280	390	B41851A3477M***
680	10 × 12.5	0.59	330	460	B41851A3687M***
1000	10 × 12.5	0.40	460	645	B41851A3108M***
1500	10 × 20	0.27	510	715	B41851A3158M***
2200	10 × 20	0.20	760	1065	B41851A3228M***
3300	12.5 × 25	0.14	1085	1520	B41851A3338M***
4700	16 × 20	0.11	1190	1665	B41851A3478M***
6800	16 × 25	0.08	1575	2205	B41851F3688M***
10000	18 × 31.5	0.07	1820	2250	B41851F3109M***

Composition of ordering code

*** = Version

- 000 = for standard leads, bulk
- 001 = for kinked leads, bulk (from $d \times l = 10 \times 20 \text{ mm}$ to $18 \times 40 \text{ mm}$)
- 002 = for cut leads, bulk (from $d \times l = 10 \times 12.5 \text{ mm}$ to $22 \times 40 \text{ mm}$)
- 003 = for crimped leads, blister (from $d \times l = 16 \times 20 \text{ mm}$ to $20 \times 40 \text{ mm}$)
- 004 = for J leads, blister (from $d \times l = 10 \times 12.5 \text{ mm}$ to $18 \times 35 \text{ mm}$)
- 006 = for taped leads, Ammo pack, lead spacing $F = 3.5 \text{ mm}$ (for $d = 8 \text{ mm}$)
- 007 = for taped leads, Ammo pack, lead spacing $F = 2.5 \text{ mm}$ (from $d = 5 \text{ mm}$ to 6.3 mm)
- 008 = for taped leads, Ammo pack, lead spacing $F = 5.0 \text{ mm}$ (from $d \times l = 5 \times 11 \text{ mm}$ to $12.5 \times 25 \text{ mm}$)
- 009 = for taped leads, Ammo pack, lead spacing $F = 7.5 \text{ mm}$ (for $d \times l = 16 \times 20 \dots 16 \times 31.5 \text{ mm}$ and $18 \times 25 \dots 18 \times 31.5 \text{ mm}$)
- 012 = for bent 90° leads, blister (for $\varnothing 16$ and 18 mm)



B41851

Standard series – 105 °C



Technical data and ordering codes – B41851

C_R	Case dimensions	ESR_{max}	$I_{AC,R}$	$I_{AC,max}$	Ordering code
120 Hz	$d \times l$	120 Hz	120 Hz	120 Hz	(composition see below)
20 °C	mm	20 °C	105 °C	85 °C	
μF		Ω	mA	mA	

$V_R = 16 V DC$

100	5 × 11	3.3	115	160	B41851A4107M***
220	6.3 × 11	1.5	190	265	B41851F4227M***
330	8 × 11.5	1.0	265	370	B41851B4337M***
470	8 × 11.5	0.71	315	440	B41851K4477M***
680	10 × 12.5	0.49	390	545	B41851F4687M***
1000	10 × 16	0.33	560	785	B41851A4108M***
1500	10 × 20	0.22	650	910	B41851F4158M***
2200	12.5 × 20	0.17	920	1290	B41851F4228M***
3300	12.5 × 25	0.12	1170	1640	B41851F4338M***
3300	16 × 25	0.12	1260	1765	B41851A4338M***
4700	16 × 25	0.09	1500	2100	B41851A4478M***
6800	16 × 31.5	0.07	1600	2240	B41851F4688M***
10000	18 × 35	0.06	1950	2730	B41851F4109M***

$V_R = 25 V DC$

47	5 × 11	5.6	83	116	B41851A5476M***
68	5 × 11	3.9	90	126	B41851F5686M***
100	6.3 × 11	2.7	140	195	B41851A5107M***
220	8 × 11.5	1.2	240	335	B41851B5227M***
330	8 × 11.5	0.80	310	435	B41851F5337M***
330	10 × 12.5	0.80	320	450	B41851A5337M***
470	10 × 12.5	0.56	380	530	B41851F5477M***
680	10 × 16	0.39	440	615	B41851F5687M***

Composition of ordering code

*** = Version

- 000 = for standard leads, bulk
- 001 = for kinked leads, bulk (from $d \times l = 10 \times 20$ mm to 18×40 mm)
- 002 = for cut leads, bulk (from $d \times l = 10 \times 12.5$ mm to 22×40 mm)
- 003 = for crimped leads, blister (from $d \times l = 16 \times 20$ mm to 20×40 mm)
- 004 = for J leads, blister (from $d \times l = 10 \times 12.5$ mm to 18×35 mm)
- 006 = for taped leads, Ammo pack, lead spacing $F = 3.5$ mm (for $d = 8$ mm)
- 007 = for taped leads, Ammo pack, lead spacing $F = 2.5$ mm (from $d = 5$ mm to 6.3 mm)
- 008 = for taped leads, Ammo pack, lead spacing $F = 5.0$ mm (from $d \times l = 5 \times 11$ mm to 12.5×25 mm)
- 009 = for taped leads, Ammo pack, lead spacing $F = 7.5$ mm (for $d \times l = 16 \times 20 \dots 16 \times 31.5$ mm and $18 \times 25 \dots 18 \times 31.5$ mm)
- 012 = for bent 90° leads, blister (for $\varnothing 16$ and 18 mm)

B41851
Standard series – 105 °C
Technical data and ordering codes – B41851

C_R 120 Hz 20 °C μF	Case dimensions $d \times l$ mm	ESR_{max} 120 Hz 20 °C Ω	$I_{\text{AC,R}}$ 120 Hz 105 °C mA	$I_{\text{AC,max}}$ 120 Hz 85 °C mA	Ordering code (composition see below)
$V_R = 25 \text{ V DC}$					
1000	10 × 20	0.27	680	950	B41851A5108M***
1500	12.5 × 20	0.18	770	1080	B41851F5158M***
2200	12.5 × 25	0.14	1090	1525	B41851F5228M***
3300	16 × 25	0.10	1400	1960	B41851A5338M***
4700	16 × 31.5	0.08	1700	2380	B41851A5478M***
6800	18 × 35	0.06	1850	2590	B41851F5688M***
10000	20 × 40	0.06	2050	2870	B41851F5109M***
$V_R = 35 \text{ V DC}$					
33	5 × 11	7.0	75	105	B41851A7336M***
47	5 × 11	4.9	93	130	B41851A7476M***
68	6.3 × 11	3.4	110	155	B41851A7686M***
100	6.3 × 11	2.3	150	210	B41851F7107M***
220	8 × 11.5	1.1	270	380	B41851F7227M***
330	10 × 12.5	0.70	350	490	B41851A7337M***
470	10 × 16	0.49	460	645	B41851A7477M***
680	10 × 20	0.34	590	825	B41851A7687M***
1000	12.5 × 20	0.23	810	1135	B41851F7108M***
1500	16 × 20	0.15	980	1370	B41851F7158M***
2200	16 × 25	0.12	1260	1765	B41851F7228M***
3300	16 × 31.5	0.09	1500	2100	B41851F7338M***
4700	18 × 35	0.07	1780	2490	B41851K7478M***
6800	18 × 40	0.06	2000	2800	B41851K7688M***

Composition of ordering code

*** = Version

- 000 = for standard leads, bulk
- 001 = for kinked leads, bulk (from $d \times l = 10 \times 20 \text{ mm}$ to $18 \times 40 \text{ mm}$)
- 002 = for cut leads, bulk (from $d \times l = 10 \times 12.5 \text{ mm}$ to $22 \times 40 \text{ mm}$)
- 003 = for crimped leads, blister (from $d \times l = 16 \times 20 \text{ mm}$ to $20 \times 40 \text{ mm}$)
- 004 = for J leads, blister (from $d \times l = 10 \times 12.5 \text{ mm}$ to $18 \times 35 \text{ mm}$)
- 006 = for taped leads, Ammo pack, lead spacing $F = 3.5 \text{ mm}$ (for $d = 8 \text{ mm}$)
- 007 = for taped leads, Ammo pack, lead spacing $F = 2.5 \text{ mm}$ (from $d = 5 \text{ mm}$ to 6.3 mm)
- 008 = for taped leads, Ammo pack, lead spacing $F = 5.0 \text{ mm}$ (from $d \times l = 5 \times 11 \text{ mm}$ to $12.5 \times 25 \text{ mm}$)
- 009 = for taped leads, Ammo pack, lead spacing $F = 7.5 \text{ mm}$ (for $d \times l = 16 \times 20 \dots 16 \times 31.5 \text{ mm}$ and $18 \times 25 \dots 18 \times 31.5 \text{ mm}$)
- 012 = for bent 90° leads, blister (for $\varnothing 16$ and 18 mm)

Technical data and ordering codes – B41851

C_R	Case dimensions	ESR_{max}	$I_{AC,R}$	$I_{AC,max}$	Ordering code
120 Hz	$d \times l$	120 Hz	120 Hz	120 Hz	(composition see below)
20 °C	mm	20 °C	105 °C	85 °C	
μF		Ω	mA	mA	
$V_R = 50 V DC$					
1	5 × 11	199	13	18	B41851A6105M***
2.2	5 × 11	90	20	28	B41851A6225M***
3.3	5 × 11	60	25	35	B41851A6335M***
4.7	5 × 11	42	30	42	B41851A6475M***
10	5 × 11	20	46	65	B41851B6106M***
22	5 × 11	9.0	67	94	B41851A6226M***
33	6.3 × 11	6.0	90	126	B41851A6336M***
47	6.3 × 11	4.2	115	160	B41851A6476M***
68	6.3 × 11	2.9	150	210	B41851F6686M***
100	8 × 11.5	2.0	190	265	B41851A6107M***
220	10 × 12.5	0.90	300	420	B41851A6227M***
330	10 × 16	0.60	410	575	B41851A6337M***
470	10 × 20	0.42	540	755	B41851A6477M***
680	12.5 × 20	0.29	700	980	B41851F6687M***
1000	12.5 × 25	0.20	950	1330	B41851F6108M***
1500	16 × 25	0.13	1260	1765	B41851F6158M***
2200	16 × 31.5	0.11	1410	1975	B41851F6228M***
2200	18 × 35	0.11	1540	2155	B41851A6228M***
3300	18 × 35	0.08	1770	2480	B41851K6338M***
4700	20 × 40	0.06	2100	2940	B41851K6478M***

Composition of ordering code

*** = Version

- 000 = for standard leads, bulk
- 001 = for kinked leads, bulk (from $d \times l = 10 \times 20$ mm to 18×40 mm)
- 002 = for cut leads, bulk (from $d \times l = 10 \times 12.5$ mm to 22×40 mm)
- 003 = for crimped leads, blister (from $d \times l = 16 \times 20$ mm to 20×40 mm)
- 004 = for J leads, blister (from $d \times l = 10 \times 12.5$ mm to 18×35 mm)
- 006 = for taped leads, Ammo pack, lead spacing $F = 3.5$ mm (for $d = 8$ mm)
- 007 = for taped leads, Ammo pack, lead spacing $F = 2.5$ mm (from $d = 5$ mm to 6.3 mm)
- 008 = for taped leads, Ammo pack, lead spacing $F = 5.0$ mm (from $d \times l = 5 \times 11$ mm to 12.5×25 mm)
- 009 = for taped leads, Ammo pack, lead spacing $F = 7.5$ mm (for $d \times l = 16 \times 20 \dots 16 \times 31.5$ mm and $18 \times 25 \dots 18 \times 31.5$ mm)
- 012 = for bent 90° leads, blister (for $\varnothing 16$ and 18 mm)



B41851

Standard series – 105 °C

Technical data and ordering codes – B41851

C_R 120 Hz 20 °C μF	Case dimensions $d \times l$ mm	ESR_{max} 120 Hz 20 °C Ω	$I_{AC,R}$ 120 Hz 105 °C mA	$I_{AC,max}$ 120 Hz 85 °C mA	Ordering code (composition see below)
$V_R = 63 V DC$					
10	5 × 11	20	46	65	B41851A8106M***
22	5 × 11	9.0	70	100	B41851F8226M***
33	6.3 × 11	6.0	100	140	B41851A8336M***
47	6.3 × 11	4.2	120	170	B41851F8476M***
68	8 × 11.5	2.9	155	220	B41851F8686M***
100	8 × 11.5	2.0	200	280	B41851F8107M***
220	10 × 16	0.90	335	470	B41851A8227M***
330	10 × 20	0.60	510	715	B41851A8337M***
470	12.5 × 20	0.42	640	895	B41851F8477M***
680	16 × 20	0.29	770	1080	B41851F8687M***
1000	16 × 25	0.20	930	1300	B41851F8108M***
1500	18 × 31.5	0.13	1260	1765	B41851F8158M***
2200	18 × 35	0.11	1650	2310	B41851K8228M***
3300	20 × 40	0.08	1950	2730	B41851A8338M***
4700	25 × 40	0.06	2250	3150	B41851F8478M***

Composition of ordering code

*** = Version

- 000 = for standard leads, bulk
- 001 = for kinked leads, bulk (from $d \times l = 10 \times 20$ mm to 18×40 mm)
- 002 = for cut leads, bulk (from $d \times l = 10 \times 12.5$ mm to 22×40 mm)
- 003 = for crimped leads, blister (from $d \times l = 16 \times 20$ mm to 20×40 mm)
- 004 = for J leads, blister (from $d \times l = 10 \times 12.5$ mm to 18×35 mm)
- 006 = for taped leads, Ammo pack, lead spacing $F = 3.5$ mm (for $d = 8$ mm)
- 007 = for taped leads, Ammo pack, lead spacing $F = 2.5$ mm (from $d = 5$ mm to 6.3 mm)
- 008 = for taped leads, Ammo pack, lead spacing $F = 5.0$ mm (from $d \times l = 5 \times 11$ mm to 12.5×25 mm)
- 009 = for taped leads, Ammo pack, lead spacing $F = 7.5$ mm (for $d \times l = 16 \times 20 \dots 16 \times 31.5$ mm and $18 \times 25 \dots 18 \times 31.5$ mm)
- 012 = for bent 90° leads, blister (for $\varnothing 16$ and 18 mm)



B41851

Standard series – 105 °C



Technical data and ordering codes – B41851

C_R 120 Hz 20 °C μF	Case dimensions $d \times l$ mm	ESR_{max} 120 Hz 20 °C Ω	$I_{\text{AC,R}}$ 120 Hz 105 °C mA	$I_{\text{AC,max}}$ 120 Hz 85 °C mA	Ordering code (composition see below)
$V_R = 100 \text{ V DC}$					
0.1	5 × 11	1658	1.5	2.1	B41851A9104M***
0.22	5 × 11	754	3.4	4.8	B41851A9224M***
0.33	5 × 11	502	5.0	7.0	B41851A9334M***
0.47	5 × 11	353	7.1	10	B41851A9474M***
0.68	5 × 11	244	9.1	13	B41851A9684M***
1	5 × 11	166	15	21	B41851A9105M***
2.2	5 × 11	75	21	30	B41851A9225M***
3.3	5 × 11	50	29	41	B41851A9335M***
4.7	5 × 11	35	32	45	B41851A9475M***
10	6.3 × 11	17	53	74	B41851A9106M***
22	8 × 11.5	7.5	98	137	B41851B9226M***
33	8 × 11.5	5.0	125	175	B41851F9336M***
33	10 × 12.5	5.0	135	190	B41851A9336M***
47	10 × 12.5	3.5	160	225	B41851B9476M***
68	10 × 16	2.4	195	275	B41851A9686M***
100	10 × 20	1.7	245	345	B41851A9107M***
220	12.5 × 25	0.75	435	610	B41851A9227M***
330	16 × 25	0.50	560	785	B41851A9337M***
470	16 × 31.5	0.35	700	980	B41851A9477M***
680	18 × 40	0.24	770	1080	B41851F9687M***
1000	18 × 40	0.17	950	1330	B41851F9108M***

Composition of ordering code

*** = Version

- 000 = for standard leads, bulk
- 001 = for kinked leads, bulk (from $d \times l = 10 \times 20 \text{ mm}$ to $18 \times 40 \text{ mm}$)
- 002 = for cut leads, bulk (from $d \times l = 10 \times 12.5 \text{ mm}$ to $22 \times 40 \text{ mm}$)
- 003 = for crimped leads, blister (from $d \times l = 16 \times 20 \text{ mm}$ to $20 \times 40 \text{ mm}$)
- 004 = for J leads, blister (from $d \times l = 10 \times 12.5 \text{ mm}$ to $18 \times 35 \text{ mm}$)
- 006 = for taped leads, Ammo pack, lead spacing $F = 3.5 \text{ mm}$ (for $d = 8 \text{ mm}$)
- 007 = for taped leads, Ammo pack, lead spacing $F = 2.5 \text{ mm}$ (from $d = 5 \text{ mm}$ to 6.3 mm)
- 008 = for taped leads, Ammo pack, lead spacing $F = 5.0 \text{ mm}$ (from $d \times l = 5 \times 11 \text{ mm}$ to $12.5 \times 25 \text{ mm}$)
- 009 = for taped leads, Ammo pack, lead spacing $F = 7.5 \text{ mm}$ (for $d \times l = 16 \times 20 \dots 16 \times 31.5 \text{ mm}$ and $18 \times 25 \dots 18 \times 31.5 \text{ mm}$)
- 012 = for bent 90° leads, blister (for $\varnothing 16$ and 18 mm)



B43851

Standard series – 105 °C

Technical data and ordering codes – B43851

C_R	Case dimensions	ESR_{max}	$I_{AC,R}$	$I_{AC,max}$	Ordering code
120 Hz	$d \times l$	120 Hz	120 Hz	120 Hz	(composition see
20 °C	mm	20 °C	105 °C	85 °C	below)
μF		Ω	mA	mA	
$V_R = 160 V DC$					
1	6.3 × 11	186	16	27	B43851A1105M***
2.2	6.3 × 11	85	23	39	B43851A1225M***
3.3	6.3 × 11	56	28	48	B43851A1335M***
4.7	6.3 × 11	40	35	60	B43851F1475M***
10	8 × 11.5	18	56	95	B43851F1106M***
22	10 × 12.5	13	91	155	B43851F1226M***
22	10 × 16	8.4	108	184	B43851A1226M***
33	10 × 16	7.5	125	213	B43851F1336M***
33	10 × 20	5.6	143	243	B43851A1336M***
47	10 × 20	4.9	150	255	B43851K1476M***
47	12.5 × 20	4.5	188	320	B43851F1476M***
68	12.5 × 20	3.0	250	425	B43851K1686M***
100	12.5 × 25	2.3	300	510	B43851F1107M***
100	16 × 25	1.8	332	564	B43851A1107M***
220	16 × 31.5	0.95	532	904	B43851F1227M***
220	18 × 31.5	0.84	560	952	B43851A1227M***
330	18 × 35	0.70	695	1182	B43851F1337M***
470	20 × 40	0.42	910	1547	B43851F1477M***
680	25 × 40	0.34	1000	1700	B43851G1687M***

Composition of ordering code

*** = Version

- 000 = for standard leads, bulk
- 001 = for kinked leads, bulk (from $d \times l = 10 \times 20$ mm to 18×40 mm)
- 002 = for cut leads, bulk (from $d \times l = 10 \times 12.5$ mm to 22×40 mm)
- 003 = for crimped leads, blister (from $d \times l = 16 \times 20$ mm to 20×40 mm)
- 004 = for J leads, blister (from $d \times l = 10 \times 12.5$ mm to 18×35 mm)
- 006 = for taped leads, Ammo pack, lead spacing $F = 3.5$ mm (for $d = 8$ mm)
- 007 = for taped leads, Ammo pack, lead spacing $F = 2.5$ mm (from $d = 5$ mm to 6.3 mm)
- 008 = for taped leads, Ammo pack, lead spacing $F = 5.0$ mm (from $d \times l = 6.3 \times 11$ mm to 12.5×25 mm)
- 009 = for taped leads, Ammo pack, lead spacing $F = 7.5$ mm (for $d \times l = 16 \times 20 \dots 16 \times 31.5$ mm and $18 \times 25 \dots 18 \times 31.5$ mm)
- 012 = for bent 90° leads, blister (for $\varnothing 16$ and 18 mm)



B43851

Standard series – 105 °C



Technical data and ordering codes – B43851

C _R 120 Hz 20 °C μF	Case dimensions d × l mm	ESR _{max} 120 Hz 20 °C Ω	I _{AC,R} 120 Hz 105 °C mA	I _{AC,max} 120 Hz 85 °C mA	Ordering code (composition see below)
V_R = 200 V DC					
1	6.3 × 11	186	16	27	B43851A2105M***
2.2	6.3 × 11	85	23	39	B43851A2225M***
3.3	6.3 × 11	56	28	48	B43851A2335M***
4.7	6.3 × 11	40	35	60	B43851G2475M***
10	8 × 11.5	21	56	95	B43851G2106M***
22	10 × 16	8.4	108	184	B43851K2226M***
33	10 × 20	5.6	144	245	B43851B2336M***
47	12.5 × 20	4.5	190	323	B43851R2476M***
68	12.5 × 25	3.3	245	417	B43851K2686M***
100	16 × 25	1.8	332	564	B43851A2107M***
220	18 × 31.5	0.95	560	952	B43851B2227M***
330	20 × 35	0.65	650	1105	B43851R2337M***
470	22 × 40	0.46	760	1292	B43851R2477M***
V_R = 250 V DC					
0.47	6.3 × 11	395	11	19	B43851F2474M***
0.68	6.3 × 11	273	13	22	B43851F2684M***
1	6.3 × 11	186	16	27	B43851F2105M***
2.2	6.3 × 11	85	23	39	B43851F2225M***
3.3	6.3 × 11	65	35	60	B43851K2335M***
4.7	8 × 11.5	40	38	65	B43851P2475M***
10	10 × 12.5	23	66	112	B43851K2106M***
22	10 × 20	8.4	120	204	B43851F2226M***

Composition of ordering code

*** = Version

- 000 = for standard leads, bulk
- 001 = for kinked leads, bulk (from d × l = 10 × 20 mm to 18 × 40 mm)
- 002 = for cut leads, bulk (from d × l = 10 × 12.5 mm to 22 × 40 mm)
- 003 = for crimped leads, blister (from d × l = 16 × 20 mm to 20 × 40 mm)
- 004 = for J leads, blister (from d × l = 10 × 12.5 mm to 18 × 35 mm)
- 006 = for taped leads, Ammo pack, lead spacing F = 3.5 mm (for d = 8 mm)
- 007 = for taped leads, Ammo pack, lead spacing F = 2.5 mm (from d = 5 mm to 6.3 mm)
- 008 = for taped leads, Ammo pack, lead spacing F = 5.0 mm (from d × l = 6.3 × 11 mm to 12.5 × 25 mm)
- 009 = for taped leads, Ammo pack, lead spacing F = 7.5 mm (for d × l = 16 × 20 ... 16 × 31.5 mm and 18 × 25 ... 18 × 31.5 mm)
- 012 = for bent 90° leads, blister (for Ø 16 and 18 mm)



B43851

Standard series – 105 °C

Technical data and ordering codes – B43851

C_R	Case dimensions	ESR_{max}	$I_{AC,R}$	$I_{AC,max}$	Ordering code
120 Hz	$d \times l$	120 Hz	120 Hz	120 Hz	(composition see
20 °C	mm	20 °C	105 °C	85 °C	below)
μF		Ω	mA	mA	
$V_R = 250 V DC$					
33	12.5 × 20	5.6	161	274	B43851K2336M***
47	12.5 × 25	4.3	203	345	B43851G2476M***
68	16 × 25	2.7	266	452	B43851F2686M***
100	16 × 31.5	1.8	364	619	B43851K2107M***
220	18 × 40	0.84	476	809	B43851F2227M***
330	22 × 40	0.56	658	1119	B43851F2337M***
$V_R = 350 V DC$					
0.47	6.3 × 11	395	10	17	B43851A4474M***
0.68	6.3 × 11	273	12	20	B43851A4684M***
1	6.3 × 11	186	15	26	B43851A4105M***
2.2	6.3 × 11	97	23	39	B43851F4225M***
2.2	8 × 11.5	85	26	44	B43851B4225M***
3.3	8 × 11.5	65	30	51	B43851F4335M***
4.7	8 × 11.5	45	38	65	B43851F4475M***
10	10 × 16	21	70	119	B43851F4106M***
22	12.5 × 20	9.0	140	238	B43851F4226M***
33	12.5 × 25	5.6	168	286	B43851F4336M***
47	16 × 25	4.0	210	357	B43851F4476M***
68	16 × 31.5	3.1	290	493	B43851F4686M***
100	18 × 35	2.3	364	619	B43851F4107M***

Composition of ordering code

*** = Version

- 000 = for standard leads, bulk
- 001 = for kinked leads, bulk (from $d \times l = 10 \times 20$ mm to 18×40 mm)
- 002 = for cut leads, bulk (from $d \times l = 10 \times 12.5$ mm to 22×40 mm)
- 003 = for crimped leads, blister (from $d \times l = 16 \times 20$ mm to 20×40 mm)
- 004 = for J leads, blister (from $d \times l = 10 \times 12.5$ mm to 18×35 mm)
- 006 = for taped leads, Ammo pack, lead spacing $F = 3.5$ mm (for $d = 8$ mm)
- 007 = for taped leads, Ammo pack, lead spacing $F = 2.5$ mm (from $d = 5$ mm to 6.3 mm)
- 008 = for taped leads, Ammo pack, lead spacing $F = 5.0$ mm (from $d \times l = 6.3 \times 11$ mm to 12.5×25 mm)
- 009 = for taped leads, Ammo pack, lead spacing $F = 7.5$ mm (for $d \times l = 16 \times 20 \dots 16 \times 31.5$ mm and $18 \times 25 \dots 18 \times 31.5$ mm)
- 012 = for bent 90° leads, blister (for $\varnothing 16$ and 18 mm)



B43851

Standard series – 105 °C



Technical data and ordering codes – B43851

C_R	Case dimensions	ESR_{max}	$I_{AC,R}$	$I_{AC,max}$	Ordering code
120 Hz	$d \times l$	120 Hz	120 Hz	120 Hz	(composition see
20 °C	mm	20 °C	105 °C	85 °C	below)
μF		Ω	mA	mA	
$V_R = 400 V DC$					
2.2	8 × 11.5	97	26	44	B43851H9225M***
3.3	8 × 11.5	65	36	61	B43851F9335M***
4.7	10 × 12.5	46	56	95	B43851F9475M***
10	10 × 20	18	80	136	B43851A9106M***
22	12.5 × 25	8.4	140	238	B43851F9226M***
33	16 × 20	5.6	168	286	B43851F9336M***
47	16 × 25	4.0	196	333	B43851F9476M***
68	18 × 31.5	3.3	294	500	B43851A9686M***
100	18 × 40	1.9	310	527	B43851K9107M***
$V_R = 450 V DC$					
2.2	8 × 11.5	97	20	34	B43851F5225M***
3.3	10 × 12.5	65	28	48	B43851F5335M***
4.7	10 × 12.5	45	32	54	B43851K5475M***
10	10 × 20	26	56	95	B43851F5106M***
22	12.5 × 25	14	100	170	B43851F5226M***
33	16 × 25	7.6	125	213	B43851F5336M***
47	16 × 31.5	4.8	155	264	B43851F5476M***
68	18 × 35	2.7	193	328	B43851A5686M***
100	20 × 40	1.8	207	352	B43851A5107M***

Composition of ordering code

*** = Version

- 000 = for standard leads, bulk
- 001 = for kinked leads, bulk (from $d \times l = 10 \times 20$ mm to 18×40 mm)
- 002 = for cut leads, bulk (from $d \times l = 10 \times 12.5$ mm to 22×40 mm)
- 003 = for crimped leads, blister (from $d \times l = 16 \times 20$ mm to 20×40 mm)
- 004 = for J leads, blister (from $d \times l = 10 \times 12.5$ mm to 18×35 mm)
- 006 = for taped leads, Ammo pack, lead spacing $F = 3.5$ mm (for $d = 8$ mm)
- 007 = for taped leads, Ammo pack, lead spacing $F = 2.5$ mm (from $d = 5$ mm to 6.3 mm)
- 008 = for taped leads, Ammo pack, lead spacing $F = 5.0$ mm (from $d \times l = 6.3 \times 11$ mm to 12.5×25 mm)
- 009 = for taped leads, Ammo pack, lead spacing $F = 7.5$ mm (for $d \times l = 16 \times 20 \dots 16 \times 31.5$ mm and $18 \times 25 \dots 18 \times 31.5$ mm)
- 012 = for bent 90° leads, blister (for $\varnothing 16$ and 18 mm)

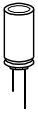

B41851, B43851
Standard series – 105 °C

Useful life

depending on ambient temperature T_A under ripple current operating conditions¹⁾

$V_R = 6.3 \dots 100 \text{ V DC}$

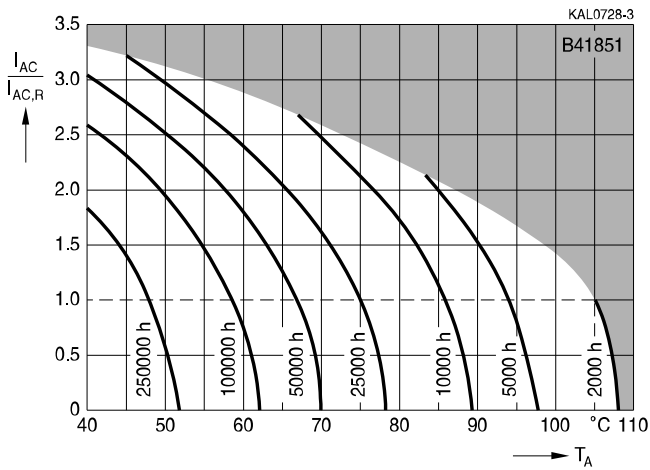

$V_R = 160 \dots 450 \text{ V DC}$

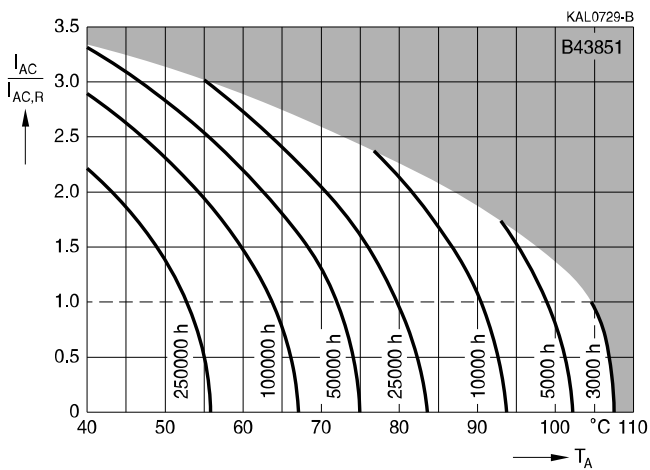

1) Refer to chapter "General technical information, 5.3 Calculation of useful life" for an explanation on how to interpret the useful life graphs.

B41851, B43851
Standard series – 105 °C



Frequency factor of permissible ripple current I_{AC} versus frequency f
 $V_R \leq 100$ V DC

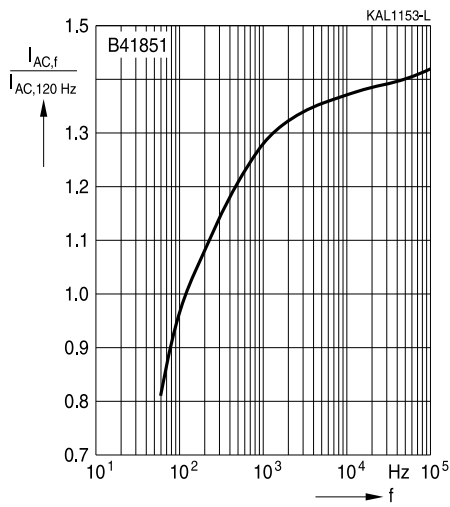

Frequency factor of permissible ripple current I_{AC} versus frequency f
 $V_R \geq 160$ V DC

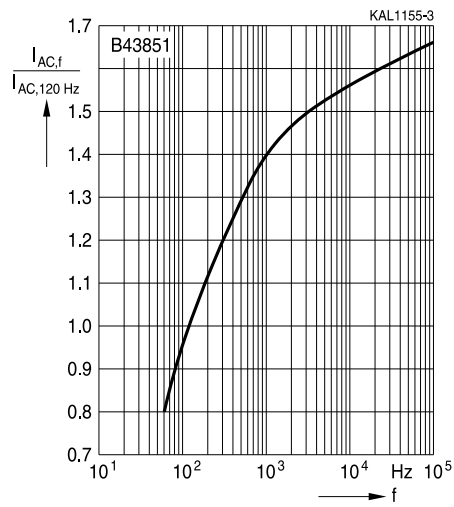

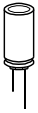

B41851, B43851

Standard series – 105 °C

Taping, packing and lead configurations

Taping

Single-ended capacitors are available taped in Ammo pack from diameter 8 to 18 mm as follows:

Lead spacing $F = 3.5 \text{ mm}$ ($\varnothing d = 8 \text{ mm}$)

Lead spacing $F = 5.0 \text{ mm}$ ($\varnothing d = 8 \dots 12.5 \text{ mm}$)

Lead spacing $F = 7.5 \text{ mm}$ ($\varnothing d = 16 \dots 18 \text{ mm}$).

Lead spacing 3.5 mm ($\varnothing d = 8 \text{ mm}$)

Last 3 digits of ordering code: 006

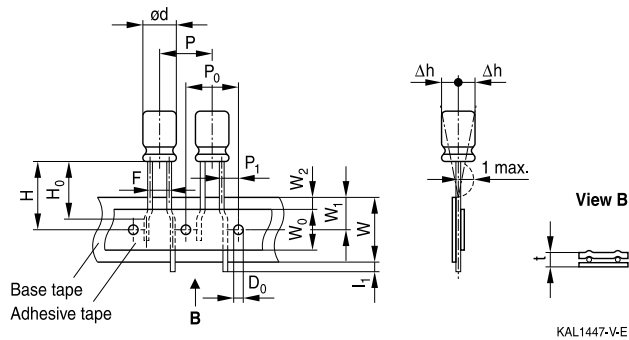

Dimensions in mm

$\varnothing d$	F	H	W	W_0	W_1	W_2	P	P_0	P_1	I_1	t	Δh	D_0
8	3.5	18.5	18.0	9.5	9.0	3.0	12.7	12.7	4.6	1.0	0.7	1.0	4.0
Tolerance	+0.8 -0.2	± 1.0	± 0.5	min.	± 0.5	max.	± 1.0	± 0.3	± 0.6	max.	± 0.2	max.	± 0.2

Leads can also run straight through the taping area.



B41851, B43851
Standard series – 105 °C

Lead spacing 5.0 mm (∅ d = 8 mm)

Last 3 digits of ordering code: 008

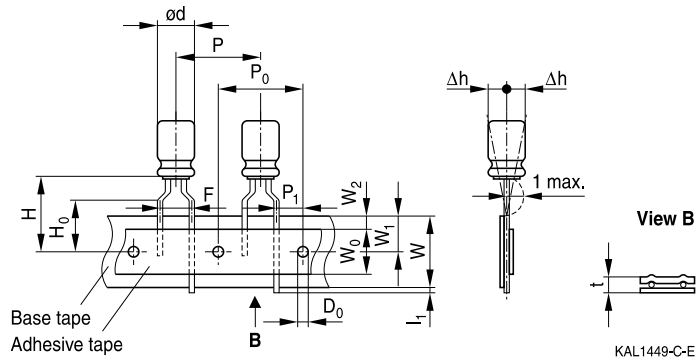

Lead spacing 5.0 mm (∅ d = 10 ... 12.5 mm)

Last 3 digits of ordering code: 008

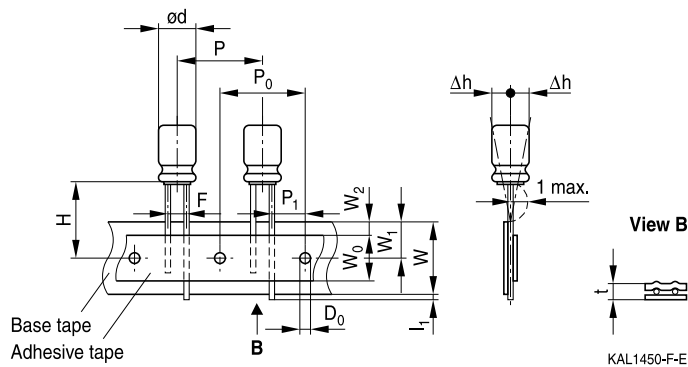

Dimensions in mm

∅ d	F	H	W	W ₀	W ₁	W ₂	H ₀	P	P ₀	P ₁	l ₁	t	Δh	D ₀
4 ... 6.3	5.0	18.5	18.0	5.5	9.0	1.5	16.0	12.7	12.7	3.85	1.0	0.6	1.0	4.0
8	5.0	20.0	18.0	9.5	9.0	1.5	16.0	12.7	12.7	3.85	1.0	0.6	1.0	4.0
10		19.0		9.5			—	12.7	12.7	3.85				
12.5		19.0		11.5			—	15.0	15.0	5.0				
Tolerance	+0.8 -0.2	±0.75	±0.5	min.	±0.5	max.	±0.5	±1.0	±0.2	±0.5	max.	+0.3 -0.2	max.	±0.2

Taping is available up to dimensions d × l = 12.5 × 25 mm.

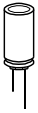

B41851, B43851

Standard series – 105 °C

Lead spacing 7.5 mm (∅ d = 16 ...18 mm)

Last 3 digits of ordering code: 009

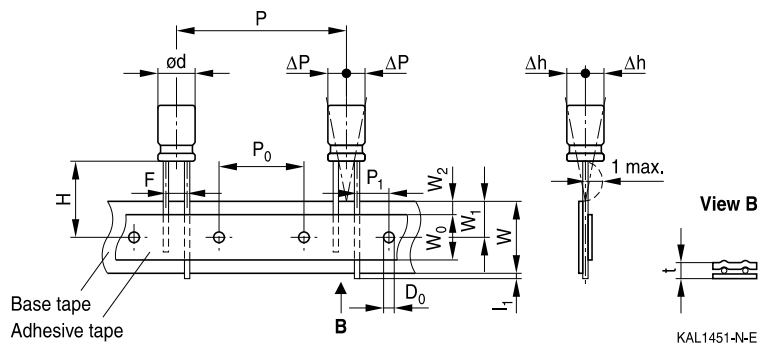

Dimensions in mm

∅ d	F	H	W	W ₀	W ₁	W ₂	P	P ₀	P ₁	l ₁	t	ΔP	Δh	D ₀
16	7.5	18.5	18.0	12.5	9.0	1.5	30.0	15.0	3.75	1.0	0.7	0	0	4.0
18														
Tolerance	±0.8	-0.5 +0.75	±0.5	min.	±0.5	max.	±1.0	±0.2	±0.5	max.	±0.2	±1.0	±1.0	±0.2

Taping is available up to dimensions d × l = 16 × 31.5 mm and 18 × 31.5 mm.



B41851, B43851
Standard series – 105 °C



Cut or kinked leads

Single-ended capacitors are available with cut or kinked leads. Other lead configurations also available upon request.

Cut leads

Last 3 digits of ordering code: 002

With stand-off rubber seal

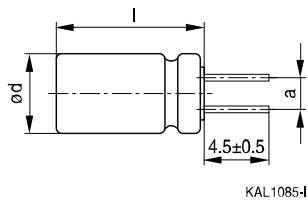

With flat rubber seal

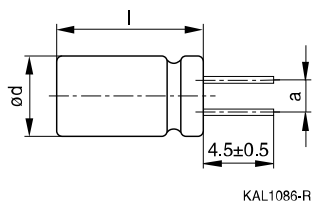

Case size d × l (mm)	Dimensions (mm) a ±0.5
10 × 12.5	5.0
10 × 16	5.0
10 × 20	5.0
12.5 × 20	5.0
12.5 × 25	5.0
16 × 20	7.5
16 × 25	7.5
16 × 31.5	7.5
16 × 35.5	7.5
18 × 20	7.5
18 × 25	7.5
18 × 31.5	7.5
18 × 35	7.5
18 × 40	7.5

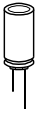

B41851, B43851

Standard series – 105 °C

Kinked leads

Last 3 digits of ordering code: 001

With stand-off rubber seal

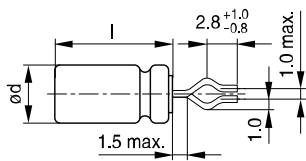

KAL1081-K

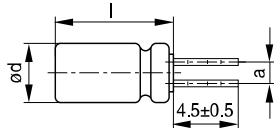

KAL1083-2

With flat rubber seal

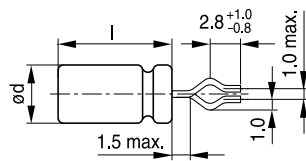

KAL1082-T

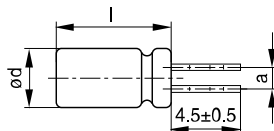

KAL1084-A

Case size d × l (mm)	Dimensions (mm) a ± 0.5
10 × 20	5.0
12.5 × 20	5.0
12.5 × 25	5.0
16 × 20	7.5
16 × 25	7.5
16 × 31.5	7.5
16 × 35.5	7.5
18 × 20	7.5
18 × 25	7.5
18 × 31.5	7.5
18 × 35	7.5
18 × 40	7.5



B41851, B43851
Standard series – 105 °C



PAPR leads (Protection Against Polarity Reversal)

These lead configurations ensure correct placement of the capacitor on the PCB with regard to polarity. PAPR leads are available for diameters from 10 mm up to 18 mm (excluding $d \times l = 12.5 \times 30/35/40$ mm).

There are three configurations available: Crimped leads, J leads, bent 90° leads

Crimped leads

Last 3 digits of ordering code: 003

With stand-off rubber seal

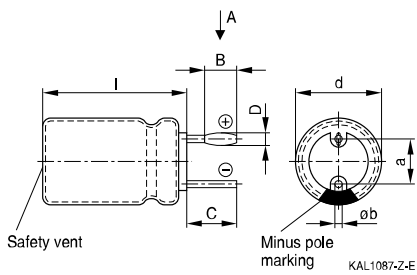

With flat rubber seal

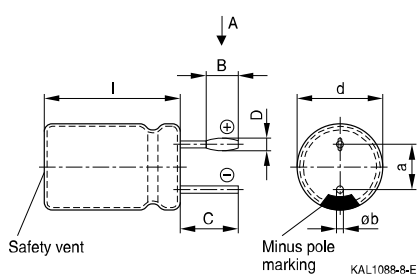

Suggestion for PCB hole diameter

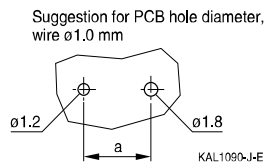
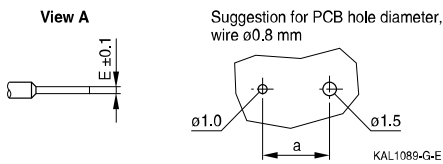

Case size $d \times l$ (mm)	Dimensions (mm)					
	B ±0.2	C ±0.5	D ±0.1	E ±0.1	a ±0.5	Øb
16 × 20	1.5	3.0	1.3	0.3	7.5	0.8 ±0.05
16 × 25	1.5	3.0	1.3	0.3	7.5	0.8 ±0.05
16 × 31.5	1.5	3.0	1.3	0.3	7.5	0.8 ±0.05
16 × 35.5	1.5	3.0	1.3	0.3	7.5	0.8 ±0.05
18 × 20	1.5	3.0	1.3	0.3	7.5	0.8 ±0.1
18 × 25	1.5	3.0	1.3	0.3	7.5	0.8 ±0.1
18 × 31.5	1.5	3.0	1.3	0.3	7.5	0.8 ±0.1
18 × 35	1.5	3.0	1.3	0.3	7.5	0.8 ±0.1
18 × 40	1.5	3.0	1.3	0.3	7.5	0.8 ±0.1

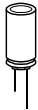

B41851, B43851

Standard series – 105 °C

J leads

Last 3 digits of ordering code: 004

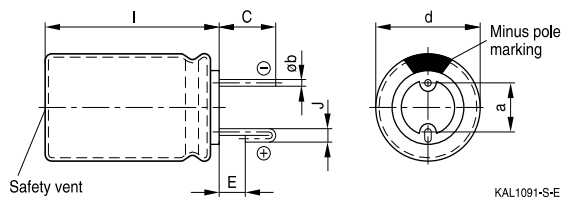

Suggestion for PCB hole diameter

Suggestion for PCB hole diameter,
wire $\varnothing 0.6$ mm

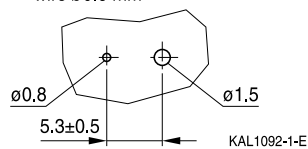

Suggestion for PCB hole diameter,
wire $\varnothing 0.8$ mm

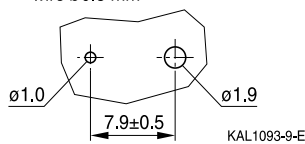

Case size d × l (mm)	Dimensions (mm)				
	C ±0.5	E ±0.5	J ±0.2	a ±0.5	∅b
10 × 12.5	3.2	0.7	1.2	5.0	0.6 ±0.05
10 × 16	3.2	0.7	1.2	5.0	0.6 ±0.05
10 × 20	3.2	0.7	1.2	5.0	0.6 ±0.05
12.5 × 20	3.2	0.7	1.2	5.0	0.6 ±0.05
12.5 × 25	3.2	0.7	1.2	5.0	0.6 ±0.05
16 × 20	3.5	0.7	1.6	7.5	0.8 ±0.05
16 × 25	3.5	0.7	1.6	7.5	0.8 ±0.05
16 × 31.5	3.5	0.7	1.6	7.5	0.8 ±0.05
16 × 35.5	3.5	0.7	1.6	7.5	0.8 ±0.05
18 × 20	3.5	0.7	1.6	7.5	0.8 ±0.1
18 × 25	3.5	0.7	1.6	7.5	0.8 ±0.1
18 × 31.5	3.5	0.7	1.6	7.5	0.8 ±0.1
18 × 35	3.5	0.7	1.6	7.5	0.8 ±0.1



Bent 90° leads for horizontal mounting pinning

Last 3 digits of ordering code: 012

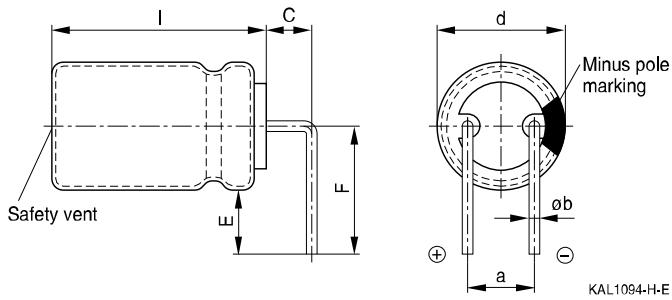

Case size $d \times l$ (mm)	Dimensions (mm)				
	$C \pm 0.5$	$E \pm 0.5$	$F \pm 0.5$	$a \pm 0.5$	$\varnothing b$
16 × 20	4.0	4.0	12.0	7.5	0.8 ±0.05
16 × 25	4.0	4.0	12.0	7.5	0.8 ±0.05
16 × 31.5	4.0	4.0	12.0	7.5	0.8 ±0.05
16 × 35.5	4.0	4.0	12.0	7.5	0.8 ±0.05
18 × 20	4.0	4.0	13.0	7.5	0.8 ±0.1
18 × 25	4.0	4.0	13.0	7.5	0.8 ±0.1
18 × 31.5	4.0	4.0	13.0	7.5	0.8 ±0.1
18 × 35	4.0	4.0	13.0	7.5	0.8 ±0.1
18 × 40	4.0	4.0	13.0	7.5	0.8 ±0.1

Bent leads for diameter 12.5 mm available upon request.

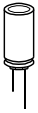

B41851, B43851

Standard series – 105 °C

Packing units and box dimensions

Ammo pack

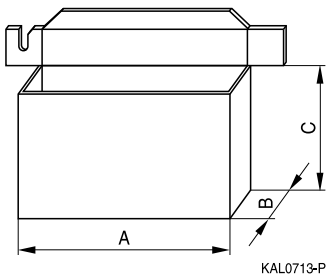

Case size d × l mm	Dimensions (mm)			Packing units pcs.
	A _{max}	B _{max}	C _{max}	
8 × 11.5	345	55	240	1000
10 × 12.5	345	55	280	750
10 × 16	345	60	200	500
10 × 20	345	60	200	500
12.5 × 20	345	65	280	500
12.5 × 25	345	65	280	500
16 × 20	315	65	275	300
16 × 25	315	65	275	300
16 × 31.5	315	65	275	300
18 × 20	315	65	275	250
18 × 25	315	65	275	250
18 × 31.5	315	65	275	250



B41851, B43851

Standard series – 105 °C



Overview of packing units and code numbers for case sizes 8 × 11.5 ... 16 × 35.5

Case size d × l mm	Standard, bulk pcs.	Taped, Ammo pack pcs.	Kinked leads, bulk pcs.	Cut leads, bulk pcs.	PAPR				
					Crimped leads, blister pcs.	J leads, blister pcs.	Bent 90° leads, blister pcs.		
8 × 11.5	1000	1000	–	–	–	–			
10 × 12.5	1000	750	–	1000	–	675			
10 × 16	1000	500	–	1000	–	675			
10 × 20	500	500	500	500	–	500			
12.5 × 20	350	500	350	350	–	300	¹⁾		
12.5 × 25	250	500	500	500	–	225	¹⁾		
12.5 × 30	200	–	–	–	–	–			
12.5 × 35	175	–	–	–	–	–			
12.5 × 40	175	–	–	–	–	–			
16 × 20	250	300	200	200	200	200	120		
16 × 25	250	300	200	200	200	200	216		
16 × 31.5	200	300	250	250	344	344	180		
16 × 35.5	100	–	100	100	150	150	150		
The last three digits of the complete ordering code state the lead configuration	000	Code	F (mm)	d (mm)	001	002	003	004	012
		006	3.5	8					
		008	5	8...12.5					
		009	7.5	16...18					

1) Available upon request



B41851, B43851

Standard series – 105 °C

Overview of packing units and code numbers for case sizes 18 × 20 ... 18 × 40

Case size d × l mm	Standard, bulk pcs.	Taped, Ammo pack pcs.			Kinked leads, bulk pcs.	Cut leads, bulk pcs.	PAPR		
							Crimped leads, blister pcs.	J leads, blister pcs.	Bent 90° leads, blister pcs.
18 × 20	175	250			175	175	200	200	120
18 × 25	150	250			150	150	200	200	120
18 × 31.5	100	250			100	100	150	150	120
18 × 35	100	–			100	100	150	150	150
18 × 40	125	–			100	100	120	–	72
The last three digits of the complete ordering code state the lead configuration	000	Code	F (mm)	d (mm)	001	002	003	004	012
		009	7.5	16...18					



B41851, B43851

Standard series – 105 °C



Cautions and warnings

Personal safety

The electrolytes used by EPCOS have been optimized both with a view to the intended application and with regard to health and environmental compatibility. They do not contain any solvents that are detrimental to health, e.g. dimethyl formamide (DMF) or dimethyl acetamide (DMAC).

Furthermore, some of the high-voltage electrolytes used by EPCOS are self-extinguishing.

As far as possible, EPCOS does not use any dangerous chemicals or compounds to produce operating electrolytes. However, in exceptional cases, such materials must be used in order to achieve specific physical and electrical properties because no alternative materials are currently known. However, the amount of dangerous materials used in our products is limited to an absolute minimum.

Materials and chemicals used in EPCOS aluminum electrolytic capacitors are continuously adapted in compliance with the EPCOS Corporate Environmental Policy and the latest EU regulations and guidelines such as RoHS, REACH/SVHC, GADSL, and ELV.

MDS (Material Data Sheets) are available on the EPCOS website for all types listed in the data book. MDS for customer specific capacitors are available upon request.

MSDS (Material Safety Data Sheets) are available for all of our electrolytes upon request.

Nevertheless, the following rules should be observed when handling aluminum electrolytic capacitors: No electrolyte should come into contact with eyes or skin. If electrolyte does come into contact with the skin, wash the affected areas immediately with running water. If the eyes are affected, rinse them for 10 minutes with plenty of water. If symptoms persist, seek medical treatment. Avoid inhaling electrolyte vapor or mists. Workplaces and other affected areas should be well ventilated. Clothing that has been contaminated by electrolyte must be changed and rinsed in water.



B41851, B43851

Standard series – 105 °C

Product safety

The table below summarizes the safety instructions that must be observed without fail. A detailed description can be found in the relevant sections of chapter "General technical information".

Topic	Safety information	Reference chapter "General technical information"
Polarity	Make sure that polar capacitors are connected with the right polarity.	1 "Basic construction of aluminum electrolytic capacitors"
Reverse voltage	Voltages polarity classes should be prevented by connecting a diode.	3.1.6 "Reverse voltage"
Mounting position of screw-terminal capacitors	Do not mount the capacitor with the terminals (safety vent) upside down.	11.1. "Mounting positions of capacitors with screw terminals"
Robustness of terminals	The following maximum tightening torques must not be exceeded when connecting screw terminals: M5: 2.5 Nm M6: 4.0 Nm	11.3 "Mounting torques"
Mounting of single-ended capacitors	The internal structure of single-ended capacitors might be damaged if excessive force is applied to the lead wires. Avoid any compressive, tensile or flexural stress. Do not move the capacitor after soldering to PC board. Do not pick up the PC board by the soldered capacitor. Do not insert the capacitor on the PC board with a hole space different to the lead space specified.	11.4 "Mounting considerations for single-ended capacitors"
Soldering	Do not exceed the specified time or temperature limits during soldering.	11.5 "Soldering"
Soldering, cleaning agents	Do not allow halogenated hydrocarbons to come into contact with aluminum electrolytic capacitors.	11.6 "Cleaning agents"
Upper category temperature	Do not exceed the upper category temperature.	7.2 "Maximum permissible operating temperature"
Passive flammability	Avoid external energy, such as fire or electricity.	8.1 "Passive flammability"



B41851, B43851

Standard series – 105 °C



Topic	Safety information	Reference chapter "General technical information"
Active flammability	Avoid overload of the capacitors.	8.2 "Active flammability"
Maintenance	Make periodic inspections of the capacitors. Before the inspection, make sure that the power supply is turned off and carefully discharge the electricity of the capacitors. Do not apply any mechanical stress to the capacitor terminals.	10 "Maintenance"
Storage	Do not store capacitors at high temperatures or high humidity. Capacitors should be stored at +5 to +35 °C and a relative humidity of ≤ 75%.	7.3 Storage conditions
		Reference chapter "Capacitors with screw terminals"
Breakdown strength of insulating sleeves	Do not damage the insulating sleeve, especially when ring clips are used for mounting.	"Screw terminals – accessories"



B41851, B43851

Standard series – 105 °C

Symbols and terms

Symbol	English	German
C	Capacitance	Kapazität
C_R	Rated capacitance	Nennkapazität
C_S	Series capacitance	Serienkapazität
$C_{S,T}$	Series capacitance at temperature T	Serienkapazität bei Temperatur T
C_f	Capacitance at frequency f	Kapazität bei Frequenz f
d	Case diameter, nominal dimension	Gehäusedurchmesser, Nennmaß
d_{max}	Maximum case diameter	Maximaler Gehäusedurchmesser
ESL	Self-inductance	Eigeninduktivität
ESR	Equivalent series resistance	Ersatzserienwiderstand
ESR_f	Equivalent series resistance at frequency f	Ersatzserienwiderstand bei Frequenz f
ESR_T	Equivalent series resistance at temperature T	Ersatzserienwiderstand bei Temperatur T
f	Frequency	Frequenz
I	Current	Strom
I_{AC}	Alternating current (ripple current)	Wechselstrom
$I_{AC,rms}$	Root-mean-square value of alternating current	Wechselstrom, Effektivwert
$I_{AC,f}$	Ripple current at frequency f	Wechselstrom bei Frequenz f
$I_{AC,max}$	Maximum permissible ripple current	Maximal zulässiger Wechselstrom
$I_{AC,R}$	Rated ripple current	Nennwechselstrom
$I_{AC,R} (B)$	Rated ripple current for base cooling	Nennwechselstromstrom für Bodenkühlung
I_{leak}	Leakage current	Reststrom
$I_{leak,op}$	Operating leakage current	Betriebsreststrom
l	Case length, nominal dimension	Gehäuselänge, Nennmaß
l_{max}	Maximum case length (without terminals and mounting stud)	Maximale Gehäuselänge (ohne Anschlüsse und Gewindebolzen)
R	Resistance	Widerstand
R_{ins}	Insulation resistance	Isolationswiderstand
R_{symm}	Balancing resistance	Symmetrierwiderstand
T	Temperature	Temperatur
ΔT	Temperature difference	Temperaturdifferenz
T_A	Ambient temperature	Umgebungstemperatur
T_C	Case temperature	Gehäusetemperatur
T_B	Capacitor base temperature	Temperatur des Becherbodens
t	Time	Zeit
Δt	Period	Zeitraum
t_b	Service life (operating hours)	Brauchbarkeitsdauer (Betriebszeit)



B41851, B43851

Standard series – 105 °C



Symbol	English	German
V	Voltage	Spannung
V _F	Forming voltage	Formierspannung
V _{op}	Operating voltage	Betriebsspannung
V _R	Rated voltage, DC voltage	Nennspannung, Gleichspannung
V _S	Surge voltage	Spitzenspannung
X _C	Capacitive reactance	Kapazitiver Blindwiderstand
X _L	Inductive reactance	Induktiver Blindwiderstand
Z	Impedance	Scheinwiderstand
Z _T	Impedance at temperature T	Scheinwiderstand bei Temperatur T
tan δ	Dissipation factor	Verlustfaktor
λ	Failure rate	Ausfallrate
ε ₀	Absolute permittivity	Elektrische Feldkonstante
ε _r	Relative permittivity	Dielektrizitätszahl
ω	Angular velocity; 2 · π · f	Kreisfrequenz; 2 · π · f

Note

All dimensions are given in mm.



Important notes

The following applies to all products named in this publication:

1. Some parts of this publication contain **statements about the suitability of our products for certain areas of application**. These statements are based on our knowledge of typical requirements that are often placed on our products in the areas of application concerned. We nevertheless expressly point out **that such statements cannot be regarded as binding statements about the suitability of our products for a particular customer application**. As a rule we are either unfamiliar with individual customer applications or less familiar with them than the customers themselves. For these reasons, it is always ultimately incumbent on the customer to check and decide whether a product with the properties described in the product specification is suitable for use in a particular customer application.
2. We also point out that **in individual cases, a malfunction of electronic components or failure before the end of their usual service life cannot be completely ruled out in the current state of the art, even if they are operated as specified**. In customer applications requiring a very high level of operational safety and especially in customer applications in which the malfunction or failure of an electronic component could endanger human life or health (e.g. in accident prevention or life-saving systems), it must therefore be ensured by means of suitable design of the customer application or other action taken by the customer (e.g. installation of protective circuitry or redundancy) that no injury or damage is sustained by third parties in the event of malfunction or failure of an electronic component.
3. **The warnings, cautions and product-specific notes must be observed.**
4. In order to satisfy certain technical requirements, **some of the products described in this publication may contain substances subject to restrictions in certain jurisdictions (e.g. because they are classed as hazardous)**. Useful information on this will be found in our Material Data Sheets on the Internet (www.tdk-electronics.tdk.com/material). Should you have any more detailed questions, please contact our sales offices.
5. We constantly strive to improve our products. Consequently, **the products described in this publication may change from time to time**. The same is true of the corresponding product specifications. Please check therefore to what extent product descriptions and specifications contained in this publication are still applicable before or when you place an order.

We also **reserve the right to discontinue production and delivery of products**. Consequently, we cannot guarantee that all products named in this publication will always be available. The aforementioned does not apply in the case of individual agreements deviating from the foregoing for customer-specific products.

6. Unless otherwise agreed in individual contracts, **all orders are subject to our General Terms and Conditions of Supply**.
7. **Our manufacturing sites serving the automotive business apply the IATF 16949 standard**. The IATF certifications confirm our compliance with requirements regarding the quality management system in the automotive industry. Referring to customer requirements and customer specific requirements ("CSR") TDK always has and will continue to have the policy of respecting individual agreements. Even if IATF 16949 may appear to support the acceptance of unilateral requirements, we hereby like to emphasize that **only requirements mutually agreed upon can and will be implemented in our Quality Management System**. For clarification purposes we like to point out that obligations from IATF 16949 shall only become legally binding if individually agreed upon.
8. The trade names EPCOS, CeraCharge, CeraDiode, CeraLink, CeraPad, CeraPlas, CSMP, CTVS, DeltaCap, DigiSiMic, ExoCore, FilterCap, FormFit, LeaXield, MiniBlue, MiniCell, MKD, MKK, MotorCap, PCC, PhaseCap, PhaseCube, PhaseMod, PhiCap, PowerHap, PQSine, PQvar, SIFERRIT, SIFI, SIKOREL, SilverCap, SIMDAD, SiMic, SIMID, SineFormer, SIOV, ThermoFuse, WindCap are **trademarks registered or pending** in Europe and in other countries. Further information will be found on the Internet at www.tdk-electronics.tdk.com/trademarks.

Release 2018-10